



EN 08/2016 ID Non contractual document

Company Profile

SINCE MORE THAN 20 YEARS, THE VETEDY GROUP HAS SPECIALISED IN THE PRODUCTION AND DISTRIBUTION OF EXOTIC TIMBERS, BOTH FOR OUTDOOR GARDEN DECKING AND INDOOR FLOORING.

EXOTIC. EXQUISITE. EXCLUSIVE.

VETEDY Group has grown at an incredible rate, thanks mainly to its revolutionary *Softline*® system which enables exterior decking to be fitted with no visible screws or oxidation.

VETEDY is an international group located in Luxembourg, Belgium, Cameroon and Indonesia and is represented the world over by its network of distributors.

The Wood flooring for the Garden is remarkable as it represents great strides forward. We are the inventors and sole manufacturers of the exclusive *Softline*® system, - a patented exterior flooring system (EP 1567731) with invisible fixings using timbers that are both extremely rot-resistant and very stable. Our experience and research have now provided some long-awaited answers to often raised questions.

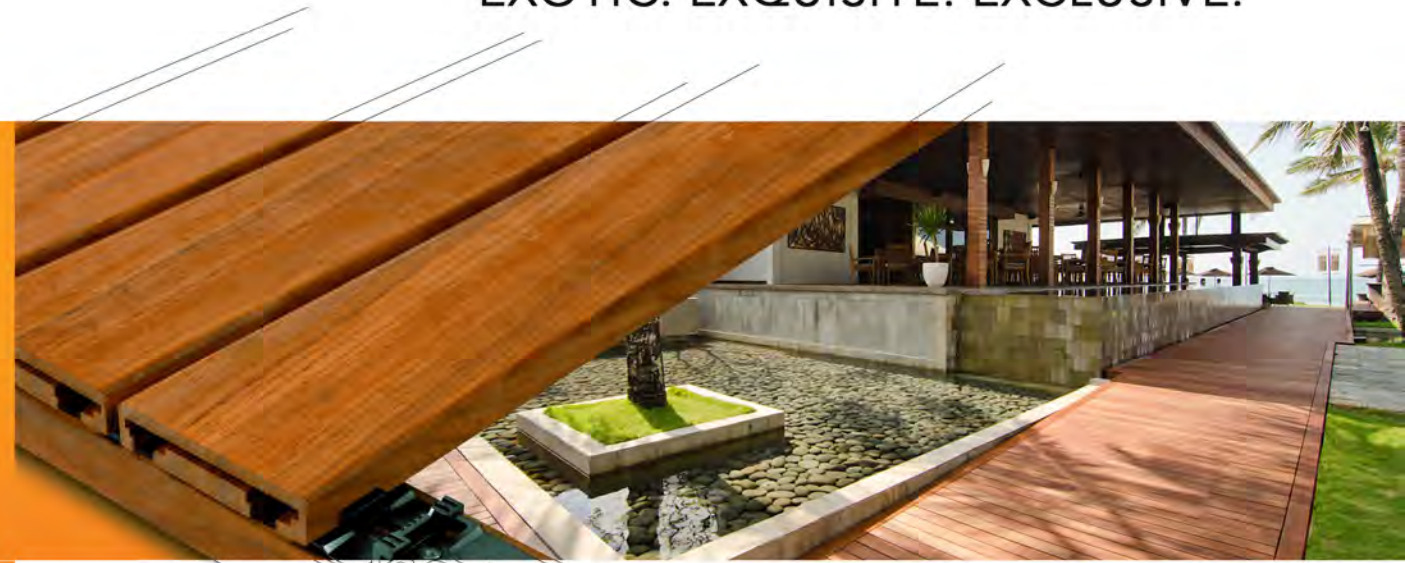

CONTACT

Tel.: (+62) 31 732 01 44
Fax: (+62) 31 73 14 612
info.vi@vetedy.com



*Showroom. We sell and install all around Indonesia

VETEDY SURABAYA
Head Office
Jl. Darmo Permai Utara,
No. 46
SURABAYA - INDONESIA

VETEDY BALI
Jl. Teuku Umar Barat,
No. 12 B
DENPASAR - BALI

VETEDY JAKARTA
Paris Residence
Jl. WR Supratman
No. 100K
Kp Utan - Cempaka Putih
15412

www.vetedyindonesia.com

It is an international organization composed of organizations' representatives of environmental protection, organizations defending the rights of indigenous peoples, forest and wood products dealers. By adhering to this charter, the Vetedy Group affirms its commitment to ensuring the preservation of our nature and attaches particular attention to respect for the rational management of natural resources and the equitable distribution of income in the country of production.



WE COMBINE DURABILITY AND AESTHETICS



MISSION

Since 25 years our mission is to push the limits of innovation in order to provide you the highest quality products defined by durability and aesthetics, with an equal priority to always serve you better!

We believe in what we do and offer.

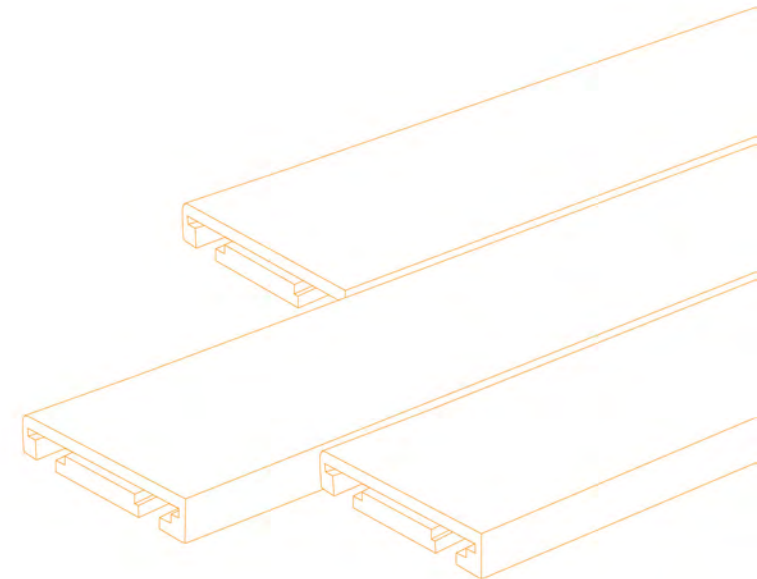

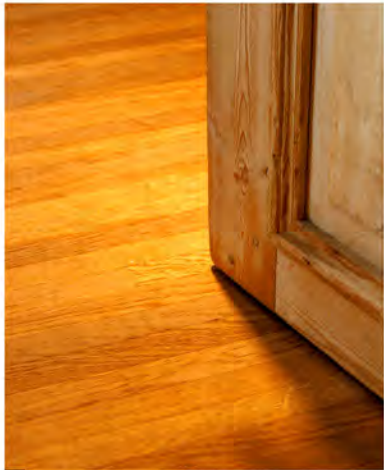

Oak Flooring

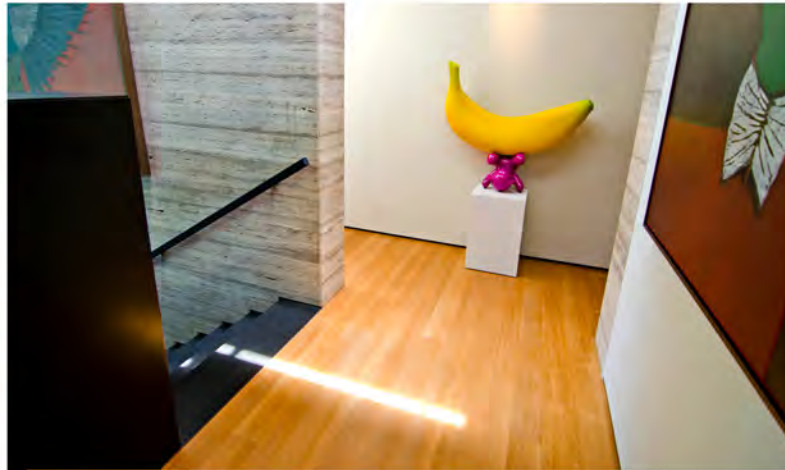

Teak Flooring

DESCRIPTION OF THE COMPANY

Vetedy is an international group located in Luxembourg, Belgium, Cameroon and Indonesia and is represented the world over by its network of distributors. The wood installed is therefore controlled at every steps from the strictly selected and legalized wood cutting to the installation.

Vetedy Group has grown at an incredible rate thanks mainly to its revolutionary *Softline*® system which enables exteriors decking to be fitted with no visible screw or oxidation. It is nowadays specialized into the production outside wood decking with its own patent system, inside wood flooring, wall coverings and exterior cladding.



Padauk Decking

Vetedy's Indonesian branches has been created in 2008 to supply the Indonesian market. Thanks to the mother's company experience, it could directly place itself among the best companies active on the flooring and decking market.

Indeed Vetedy Indonesia had the chance to benefit from the knowledge and the international reputation of Vetedy Group and due to it's long a profitable experience, it has provided some long committed answers to often raised questions.

OUTDOOR DECKING: THE WOOD. ROT-PROOF. STABLE

Our exceptional varieties of wood: Padauk, Merbau, Teak and Kuku have been chosen for their technical properties, perfectly suited to the most varied climatic conditions. Our products are dried to an average moisture content of 13% (+/- 2%) and are perfectly rot-proof without any chemical treatment and very stable regardless of the external conditions.

Padauk, African species has been specially chosen for its exceptional technical qualities and its contemporary shades and tone. It is produced in Cameroon.

The Asian finishes are sourced from Indonesia for **Merbau** and **Kuku** and Myanmar / Indonesia for **Teak**.

All our production from different continents is carefully selected and controlled by our company. The restricted number of species that we have selected for our decking is due to our strict criteria. Those woods have been chosen for their stability, anti-twist faculty, crack resistance, price and availability on the legal market

WOODEN SPECIES

NATURAL ASPECT

Padauk



Merbau



Teak



Kuku



VETEDY WOOD CLEANING

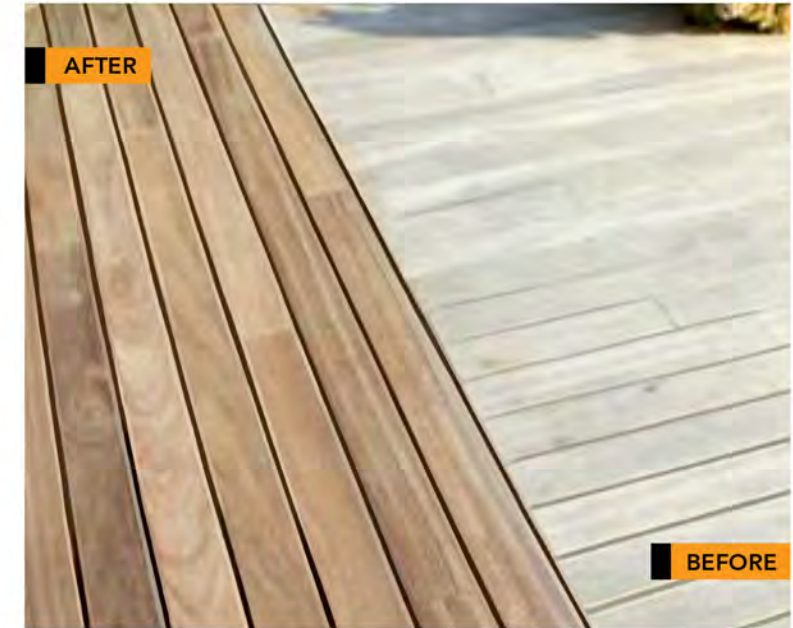

Any wood changes its color because of UV's and turns grey because of rain and pollution. We always suggest our customers to leave the wood natural and to clean it with our cleaning soap, to give their decking its new brightness as if they just came to install it. This process can be made once or twice per year. The benefits are huge: it's fast, easy and cheaper compared to any kinds of coating.



THE ADVANTAGES OF THE WOOD

- ▶ Class I rot-proof wood.
- ▶ Very stable wood, oven-dried, guaranteeing very little distortion.
- ▶ Selected high-grade wood.
- ▶ Smooth anti-slip surface, without splinters.
- ▶ Wood without any need for preliminary treatment.
- ▶ Planks of fixed lengths, precision cut, avoiding on-site trimming.
- ▶ Pleasant material, never too hot, never too cold.

OUTDOOR DECKING: EXCLUSIVITY OF THE SYSTEM

The fixation is a revolutionary system enabling the installation of planks without any apparent screw, improving both the resistance of the structure (no more weak points in the plank or in shearing the screw) and gives perfectly homogeneous aesthetics.

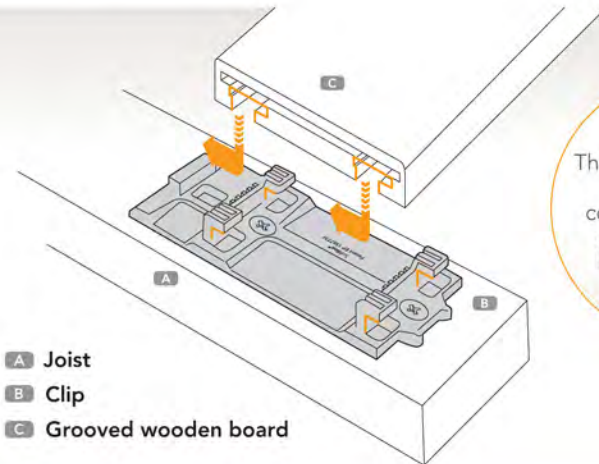
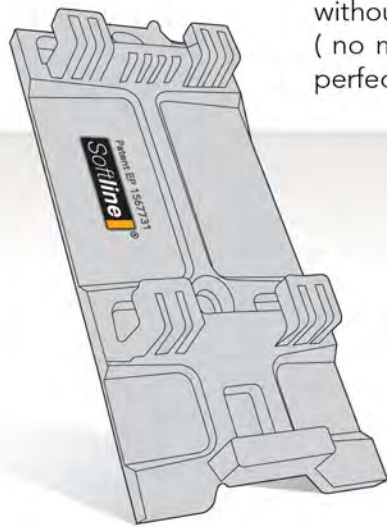

This system, designed in very resistant composite material, guarantees long-lasting durability.

THE WOOD PROFILE IS OFFERED IN TWO SIZES

20 x 100 x 800-2400* mm or
20 x 90 x 900-1800* mm

*depending wood species

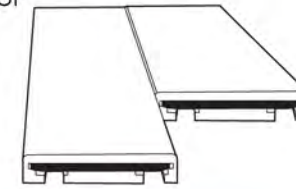

MOLDED TONGUE AND GROOVES AT EACH EXTREMITY

Ensures perfect junction between two strips.

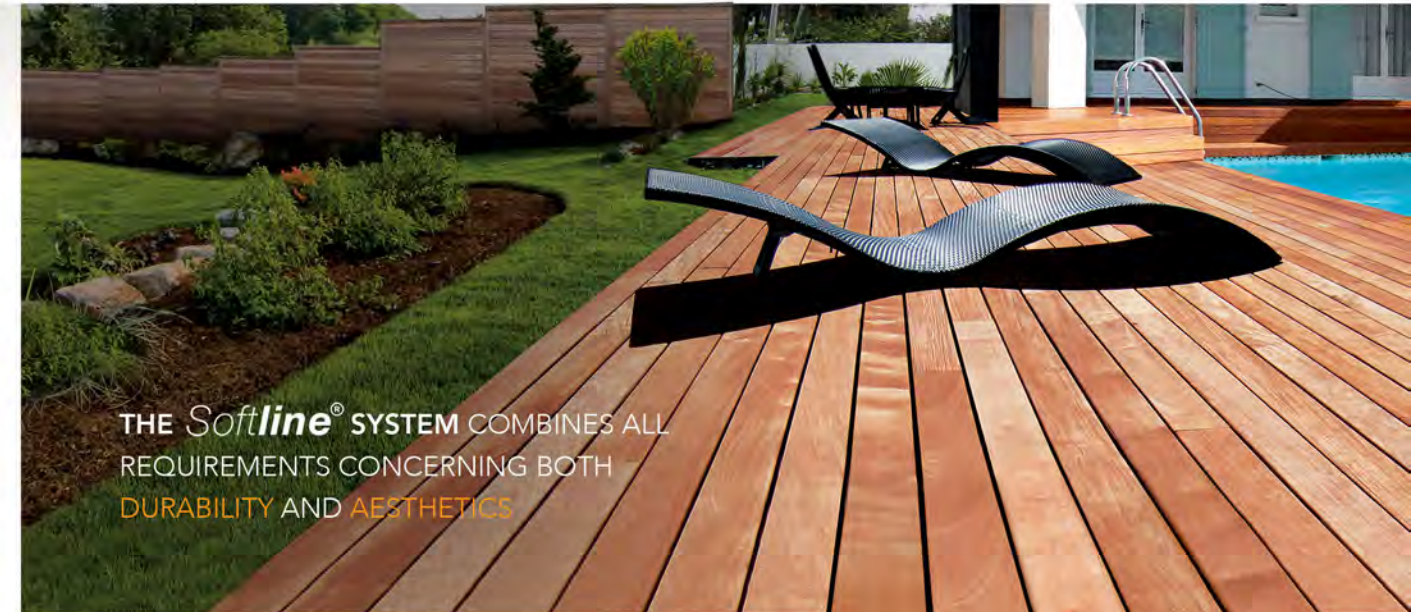
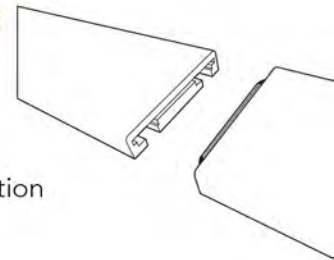

THE *Softline*® SYSTEM COMBINES ALL REQUIREMENTS CONCERNING BOTH DURABILITY AND AESTHETICS

THE ADVANTAGES OF *Softline*® SYSTEM

- > Enables invisible fixation to the support.
- > Composite material with high mechanical strength, guaranteeing a high quality system.
- > Flexibility in compression and/or expansion, allowing re-positioning after stress (unlike steel).
- > Eliminates the stage of pre-drilling and countersinking.
- > Allows lateral movement between the planks without any resulting deterioration of the wood.
- > Allows the strips to be isolated from the support.
- > Provides a guarantee of long-lasting durability.
- > Shortens the installation time.
- > Allows even jointing between strips.
- > Prevents the twist in the planks.
- > Ensures free circulation of air.
- > Reinforces the general aspect thank to a wooden frame fixed with non visible screws.
- > Allow a vertical installation (facade, fence, planter,...).
- > Possibility of removing and replacing planks.

In order to guarantee a perfect assembling with our *Softline*® system, we mould the specific grooves, with a machine specially designed for this purpose, in our workshop.

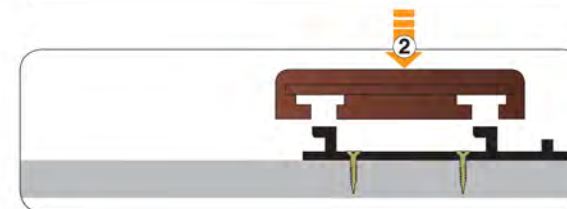
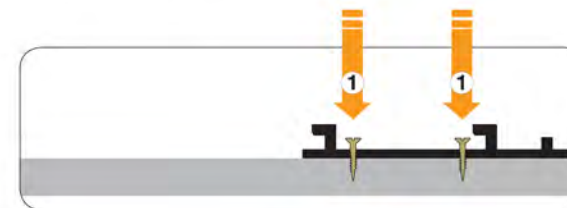

THE FIXATION. INVISIBLE. UNBREAKABLE

The *Softline*® fixation system allows free circulation of air and movement between the planks without any resulting deterioration of the wood.

INDOOR FLOORING: OUR SELECTED PARQUETS

We offer you the possibility to choose among exclusive species, type of flooring, finishings and skirtings.



WOOD SPECIES

Name	Origin
Afzelia Pachyloba (Doussie)	Kamerun, Gabon
Sonokeling	Indonesia
Iroko	Kamerun, Gabon
Merbau	Indonesia
Niove	Kamerun, Gabon
Padauk	Kamerun, Gabon
Teak	Indonesia
Wenge	Republic of Kongo
Zingana (Zebrano)	Kamerun, Gabon
Bamboo	Indonesia
Oak*	Western Europe
Kuku	Indonesia

*Oak can be declined in tens of possibilities: brushed, stained, oiled, smoked or in a combination of a different finishings

EXOTIC. EXQUISITE. EXCLUSIVE.

- 1 FLOORING
- 2 GLUE
- 3 PRIMER
- 4 LEVELLER
- 5 CONCRETE



TYPE OF FLOORING



Solid



Engineering



Finger Joint



Skirting

FINISHING

Factory Finished - Coated on site: oil or varnish

All woods are available in different sizes and with or without bevels*:

Thickness : from 10 to 20 mm
Width : from 50 to 140 mm
Length : from 400 to 1800 mm

(*depending on the species and types of flooring)



FROM PRODUCTION TO INSTALLATION

Depending on its future use, the wood passes through not less than 12 steps of production. This timeline explains the basic steps which the wood has to go through before being installed in your project.



DECKING PROCESS

Moulding machine.

The *Softline* machine is unique and has been entirely constructed upon our needs. This custom machine is 80% automatic.

The other 20% is the quality control made on every single plank.

Pedestals have been made to level the decking at the good height.

Concrete pedestals and battens installed ready to welcome the *Softline* clip and decking.

The timeline has only shown the major steps, but there is actually much work before, in between and after. Indeed to insure the best quality, a quality control is made between each steps. The installation also requires other products such as the *Softline* clip, glue, waterproofing, and other products, which also need a long process of production.

Logs waiting to be cut. Logs come from Papua and Java.

The logs are cut in planks. How to cut the log depends on the desired grade and quality.

Wood waiting to be dried in the KD chamber.

The KD chambers.

After the KD chambers, the moisture of this wood is controlled for the optimistic %.

FLOORING PROCESS



After the KD, the wood is controlled, selected and sanded.

Moulding machine.

This step consists of varnishing by spraying the edge of the planks.

Coating line, which consists of 18 distinctive machines.

One layer of varnish consists of three different machines: sanding, coating roll and UV lamps. Wood can contain 5 to 9 layers.

The coating line is the final step of the flooring manufacture. It is therefore strictly controlled.

Moisture between 2% and 4% ready for primer and leveler.

Area covered with leveler and primer to level and waterproof before the flooring installation.

Installation of the flooring.

The production of our decking and flooring is mostly done in Indonesia. Different steps are required to deliver the product that the customers choose. The flooring requires minimum 11 steps and the decking requires 8 steps.

VETEDY'S ACHIEVEMENTS

With over 200 distributors around the world, Vetedy Group has achieved great references. It is our pride to present you a few of them here under.



Softline Merbau Decking - Samaya Resto & Villa, Bali



Softline Kuku Decking - Bali



Softline Merbau Decking - Gili



Softline Kuku Decking - Jakarta



Softline Kuku Decking - Jakarta



Softline Padauk Decking - Bali



Stained Merbau Flooring - Jakarta



Softline Merbau Decking - Jakarta



Softline Merbau Cladding - Surabaya



Softline Teak Decking - Malang



Softline Teak Decking - Surabaya

VETEDY'S ACHIEVEMENTS



Softline Merbau Decking - Bali



Solid Teak Flooring - Bali

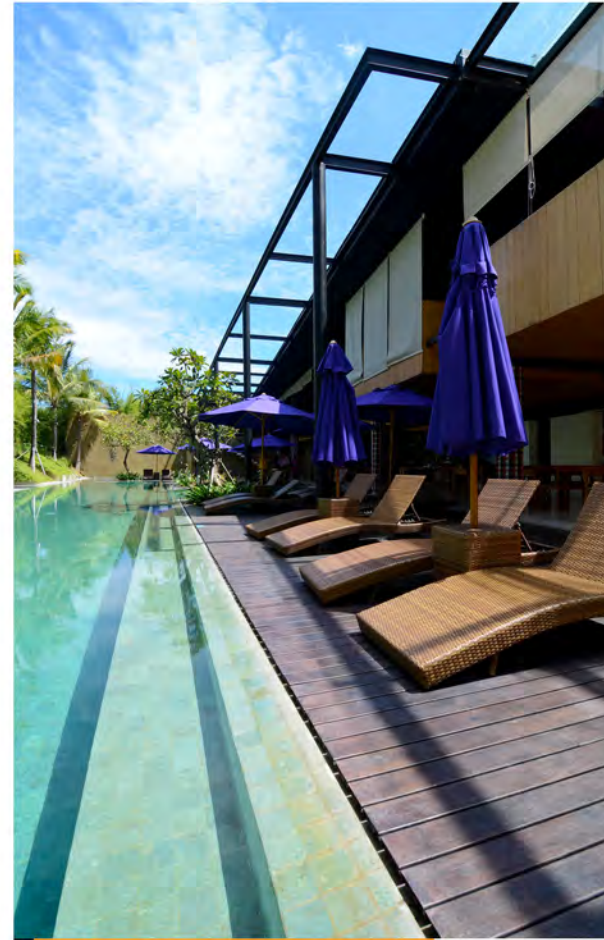

Softline Merbau Decking - Taum Resort, Bali

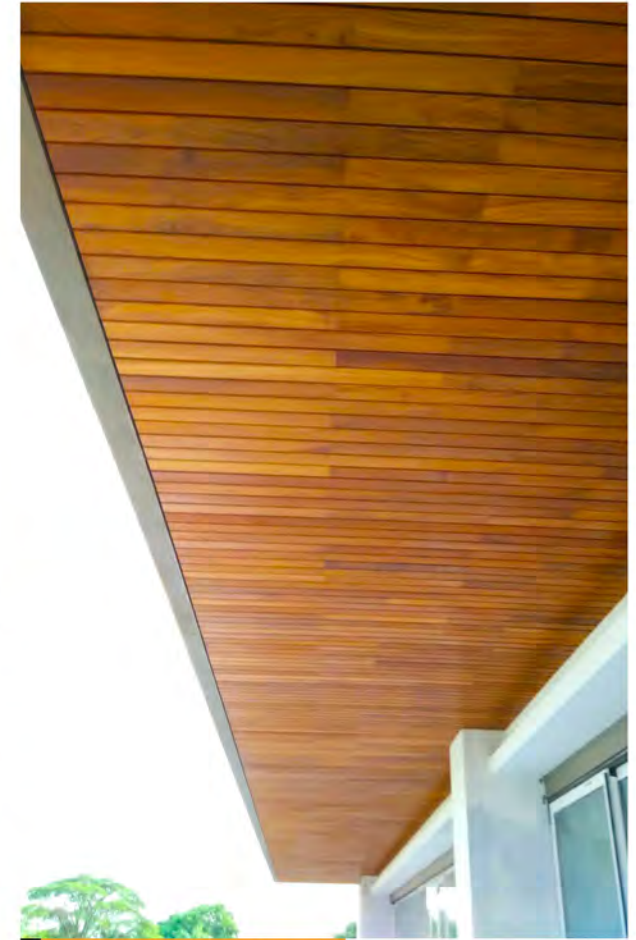

Softline Teak Ceiling - Jakarta



Softline Padauk Decking, Jakarta

VETEDY'S ACHIEVEMENTS



Softline Kuku Decking - Bali



Softline Merbau Decking - Bali



Softline Teak Decking - Jakarta



Softline Merbau Decking - Bali



Softline Kuku Decking - Bali



Softline Merbau Decking - Jakarta

VETEDY'S ACHIEVEMENTS



Teak Flooring - Jakarta



Project of 4.500 sqm

Softline Kuku Decking - 66 Hotel Bali



Project of 1.300 sqm

Softline Merbau Decking - The Samaya Bali



Softline Teak Cladding - Jakarta

SOME OF OUR WELL KNOWN CUSTOMERS OF VETEDY GROUP

INTERNATIONAL

Famous Singers • Ministers • European Council in France • Amneville Casino Rank 4th
 World Renowned Football Players • Sport City Tower Doha • Piri Reis University Istanbul • Mondorf Casino
 Ice Skater World Champion • 5 Stars Hotels: Conrad, Ritz Carlton • Luxembourgish Royal Family
 UNESCO Project Malta • Famous Fashion Designers • CEO of Multinationals Corporation

INDONESIAN

Ciputra - Jakarta • Double 66 - Bali • Samaya Hotels - Bali • Anvaya - Bali • Tirtha Bridal - Bali
 Bali Hai - Lembongan • Jambu Luwuk - Gili • Park Royal - Bogor • Fraser Residence - Jakarta
 Bandung Governor - Bandung • Citicon - Jakarta • Radisson Blu - Bali • DeVasa - Surabaya • Costa Villa - Jakarta
 Shangrila - Bali • Prama Sanur Beach Hotel - Bali

THEY TRUSTED US



Our Environmental Concerns - Certificates

Wood has always been the core material in the Vetedy products. Therefore it is our wish and obligation to think about the consequences for the environment and respect environmental issues and values to heart: from the origin of the wood to the reduction of waste.

Wood is infinitely renewable. It is the world's most renewable source and environmentally friendly raw material. We can always replace it. Thanks not only to all our certifications but also to our yearly expansion, we are able to control the whole supply chain and we can therefore insure ourselves about the origin of each tree.

In order to minimize our waste production, wastes are being re-used for other means as fuel for the drying ovens or to make finger joints parquets recycled from the leftovers.



FSC: FSC is a global, not-for-profit organization dedicated to the promotion of responsible forest management worldwide. Their members include some of the world's leading environmental NGOs (WWF and Greenpeace), businesses (Tetra Pak and Mondi PLC) and social organizations.



Made in Indonesia: We are proud to explain to our customers that our Indonesian wood species and some of our material are fully manufactured in Indonesia. This gives us the satisfaction to contribute to the Indonesian economy growth by our small fingerprint.



VLK: Timber Legality Assurance System. We're very proud to be the first company of Indonesia to have this certification. This proves the legal origin of each single tree by a sustainable forest management. It is nowadays necessary for both the Indonesian market & for the export as many countries don't allow their companies to import without this certificate.



IBAMA & OLB: These certificates attest compliance with the law by a logging company and the traceability of its wood products. It concerns not only the forest law, but also those related to finances, employment, the environment, etc.



Luxembourg Product: The head quarter from Vetedy Group as well as the R&D department is based in the Grand Duchy of Luxembourg. The founder and the history of Vetedy's products are originally from Luxembourg too.



Made in Europe: All our products are following the European standards such as all the ISO and DTU norms. Our *Softline*® is a European wide patent system.

Other certifications: Vetedy Group won the Belgian entrepreneur competition in 2009. Our Techniclic System for façade, ceilings, inside wall coverings is a worldwide patent system.

DISTRIBUTORS LIST

We are represented by over 200 distributors in the world.



Austria - Azerbaidjan - Belarus - Belgium - Bulgaria
 Canada - Croatia - Cyprus - Czech Republic - Denmark
 Egypt - Finland - France - French islands - Germany
 Greece - India - **Indonesia** - Iran - Ireland - Israël
 Italy - Japan - Kazakhstan - Lebanon - Latvia - Lithuania
 Luxembourg - Malaysia - Malta - Marocco - The Netherlands
 Norway - Poland - Portugal - Romania - Russia - Slovenia
 Sweden - Switzerland - Tunisia - Turkey - United Arab Emirates
 United Kingdom - United States of America - Singapore - Spain